

ELITE

POCKET S7

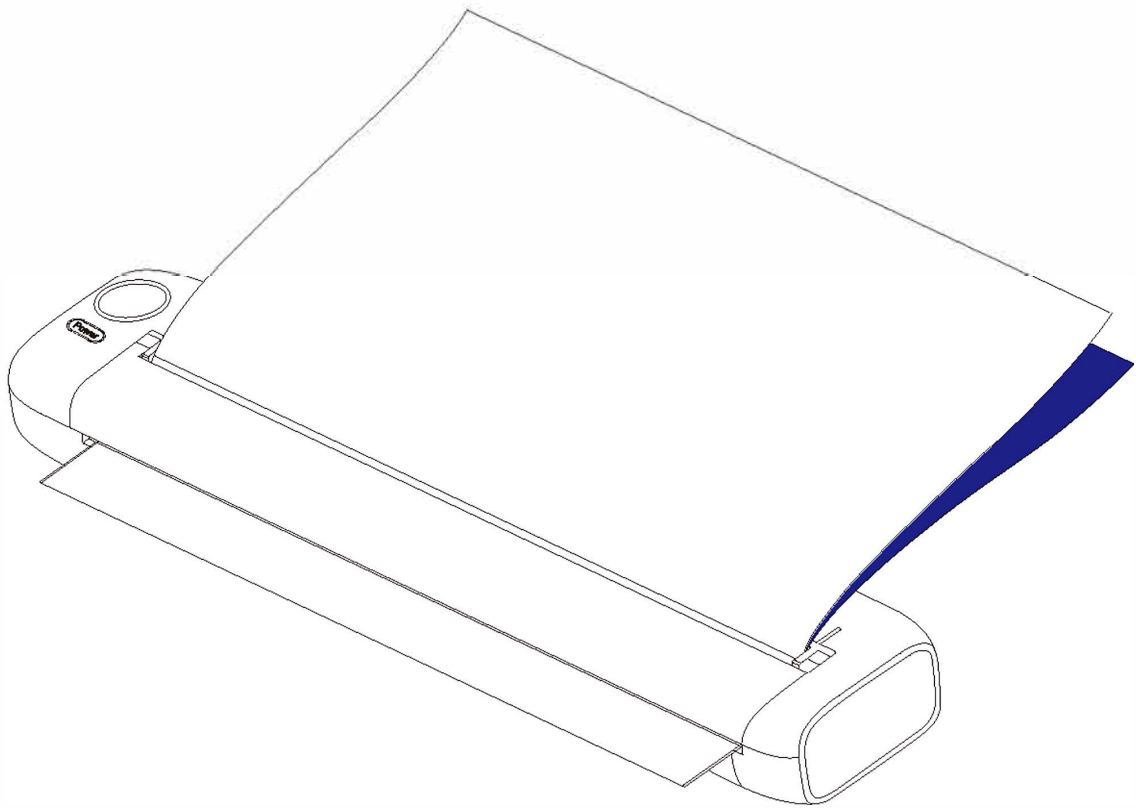

USER MANUAL

Display Screen

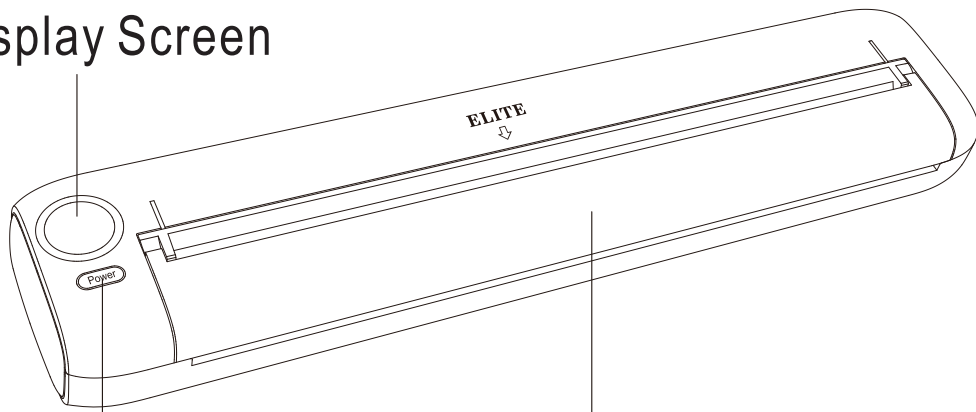

Power Button

Flap

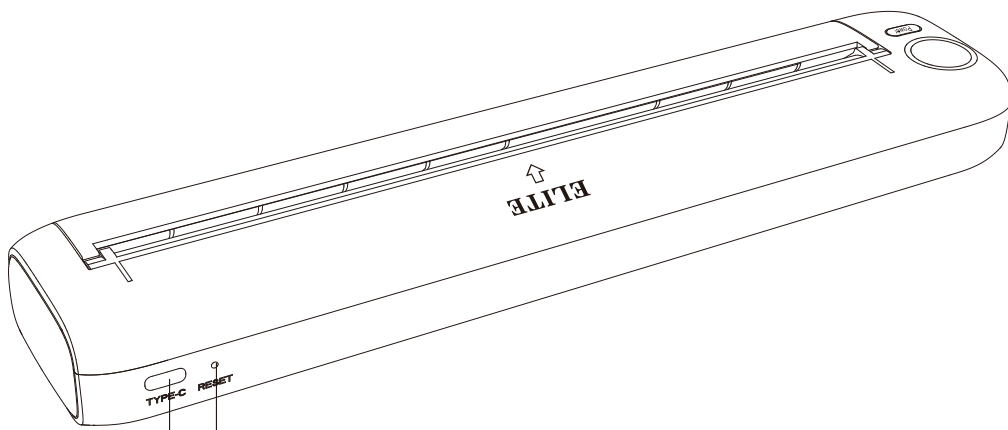

Reset Hole

Type-c Charging Port

Mobile Phone/Pad

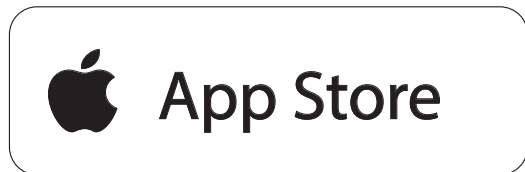

Get/Install the **Elite Stencil** app on phone or pad

Apple Mac

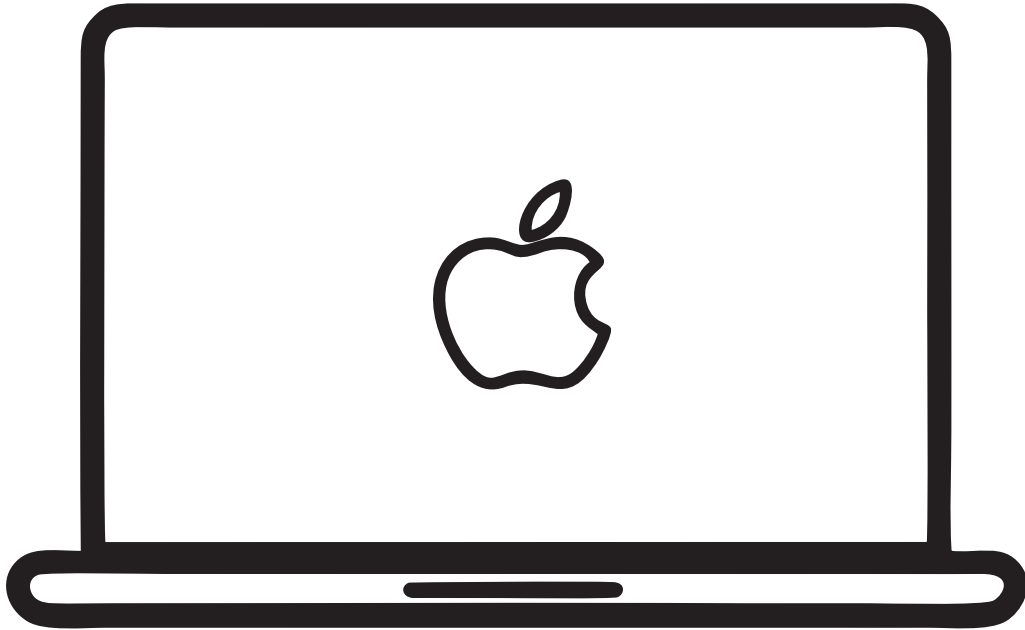

1.Download: Get the Mac client from www.elitetattoo.com/pages/elite-stencil-app

2.Installation: Follow the on-screen instructions to install the software.

3.Bluetooth Connection: Connect the ELITE Pocket S7 to your Mac via Bluetooth.

Instructions for Use

1. Power On

Press and hold the Power button for 3 seconds to turn on the printer

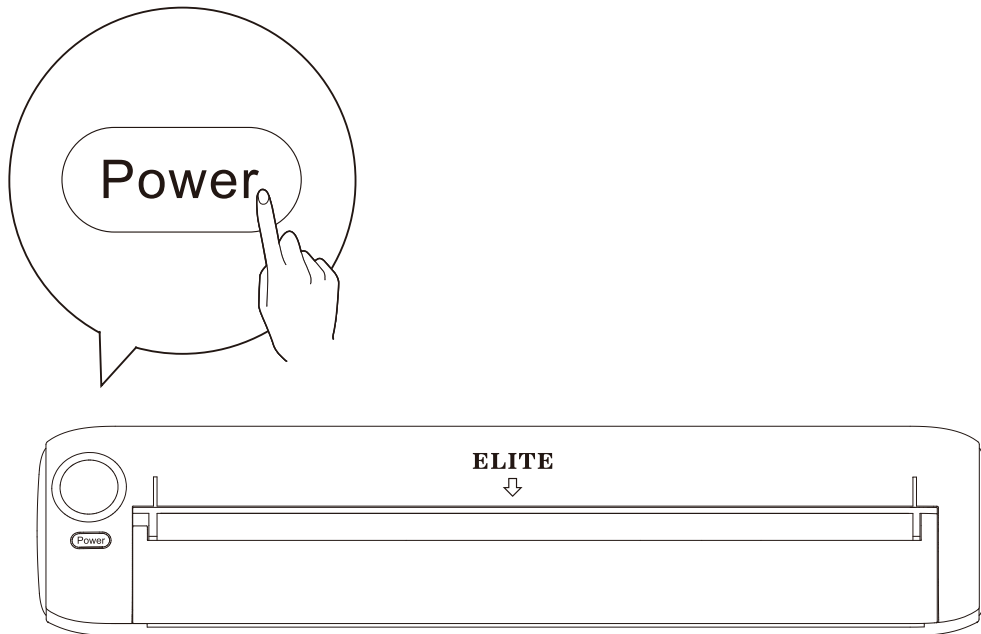

Note:

- Press and hold the Power button for 3 seconds to turn on/off.
- Press the Power button once to feed the paper.
- Press the Power button three times to print a self-test page.

Instructions for Use

2.Loading Paper







- Ensure the Master Sheet is on top and the Stencil Carbon Sheet is on the bottom.
- Hold the paper with both hands, making sure it is straight and properly aligned.
- Gently insert the paper into the printer's feeder, allowing the roller to pull it into the correct position.

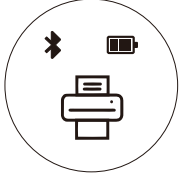

Note:

If you need to remove the paper halfway through, lift the **flap** with both hands simultaneously and gently pull out the paper.

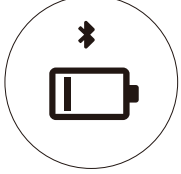
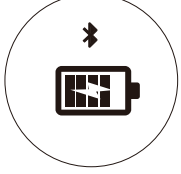
Display Screen Indicators

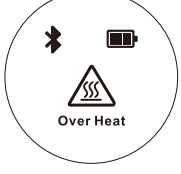
	<p>Power-on</p>
	<p>Paper ready</p>
	<p>Printing</p>
	<p>Print complete</p>
	<p>Low battery warning</p>
	<p>Battery charging</p>
	<p>OTA upgrade</p>
	<p>Overtemperature warning</p>

CAUTIONS:

1. **Printhead Care:** Regularly clean with an alcohol wipe for clear prints.
2. **Temperature:** Avoid exposing the printer to extreme heat.
3. **Battery:** Ensure sufficient charge for optimal print quality.

TROUBLESHOOTING:

1. **Bluetooth:** Check if Bluetooth is active, reconnect if needed.
2. **Clarity:** Unclear prints? Clean the printhead using an alcohol wipe.

Insert the wipe as regular paper and quickly press the power button three times to feed it through. Repeat as needed for thorough cleaning.

3. Ensure proper paper alignment and reduce print density if it's set too high.

4. For more tips and tutorials, visit our YouTube channel at: www.youtube.com/@elitetattooofficial

WWW.ELITETATTOO.COM

VISIT OUR YOUTUBE CHANNEL



ELITE TATTOO OFFICIAL

FOR USAGE INSTRUCTIONS



ELITETATTOOOFFICIAL